

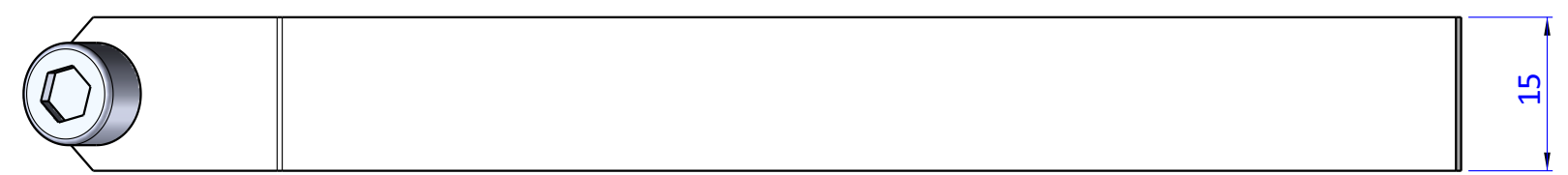

THE PROPERTY OF THE DRAWING IS ESTABLISHED BY LAW. IT IS FORBIDDEN TO PRODUCE OR SHOW IT TO THIRD PART. WITHOUT A WRITTEN AGREEMENT.

Item	Name	Q.ty
1	R.6.SCH	1
2	V.TCE6x16	1
3	WSL.2080.VU	1

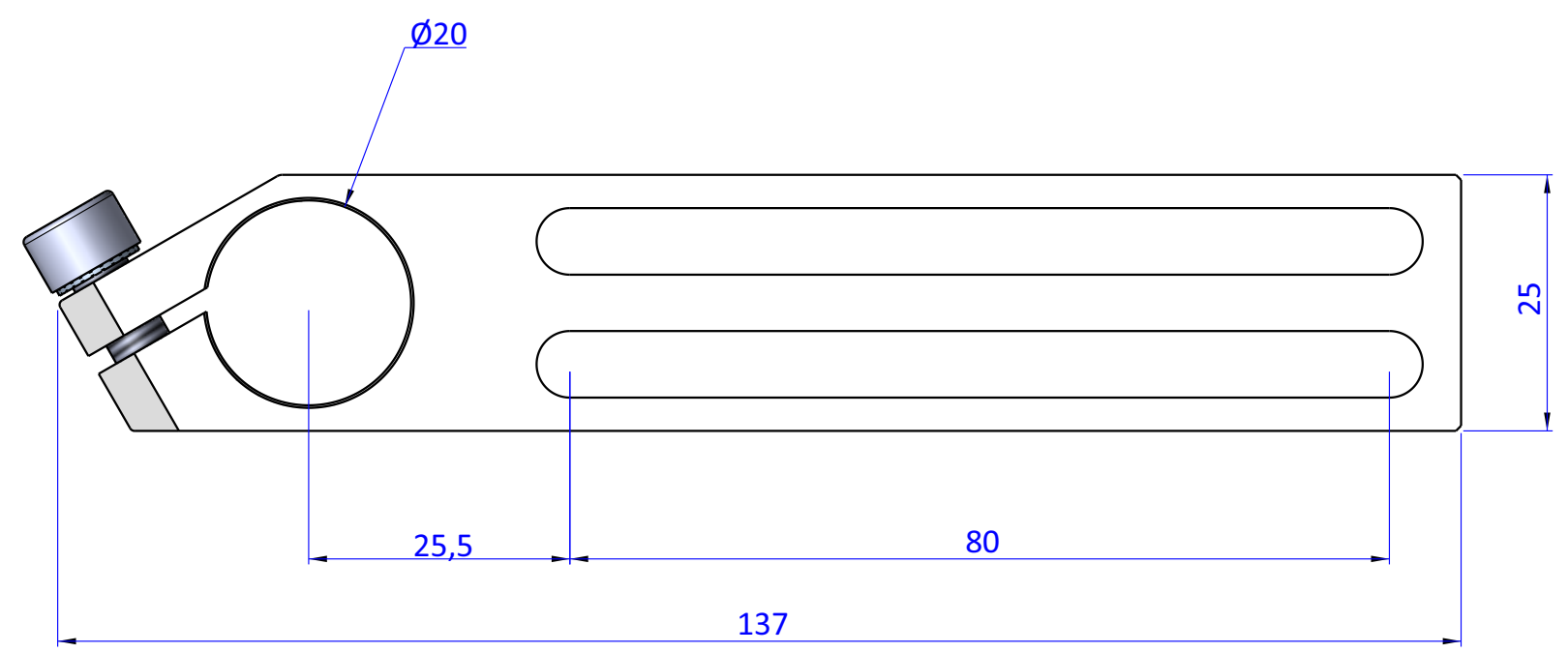
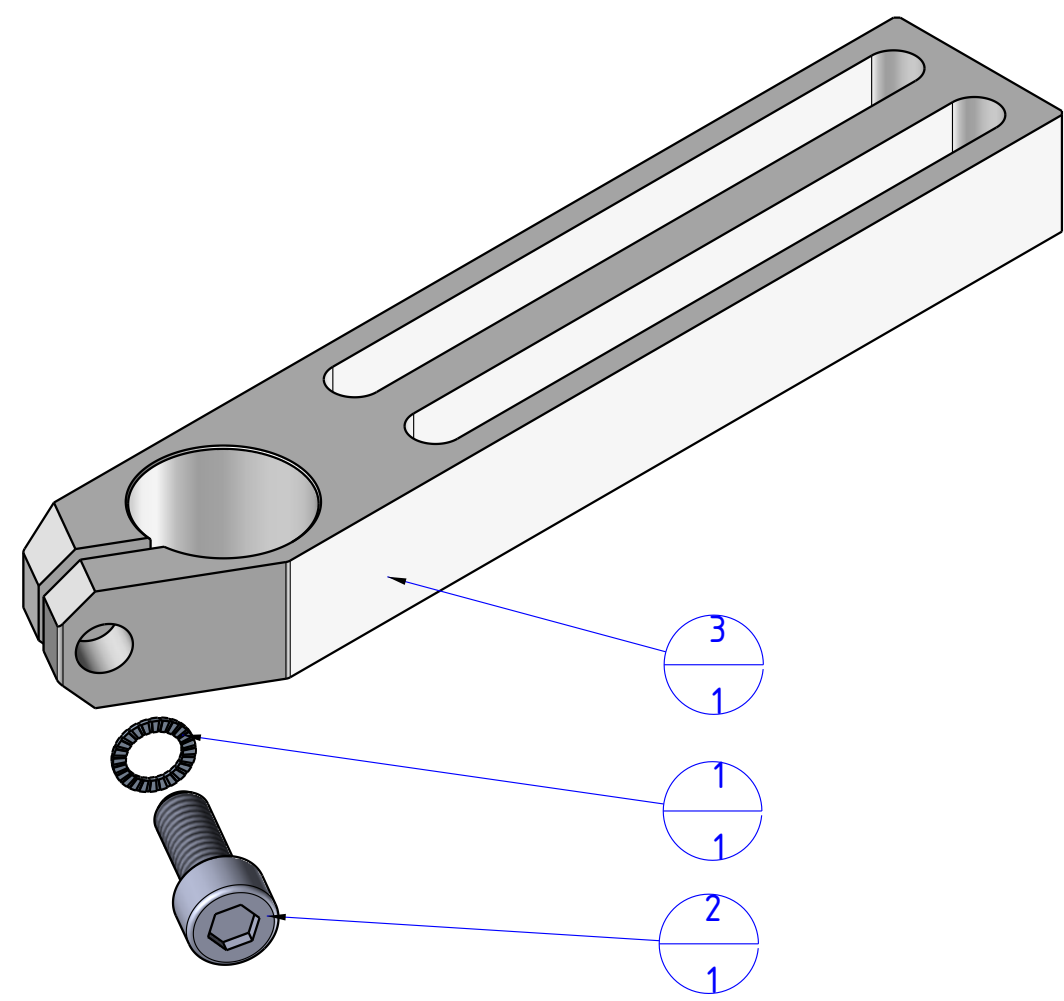

Format A3
UNI 936-76

 FPS FPSERVICES AUTOMATION		DESIGNED FROM FPS Automation		REVIEW A	
		DATE 09/04/2020	WEIGHT 0,072kg		
GENERAL TOLERANCE UNI - ISO 2768 CLASSE f	DESCRIPTION CA.WSL.2080.VU		CODE CA.WSL.2080.VU		